

T&J

www.tjelec.com.sg



T&J Electric (Singapore) Pte Ltd

Tel : +65 6547 4333 Fax : +65 6547 4666

T&J Electric (Malaysia) Sdn Bhd

Tel : +603 7865 1613 Fax : +603 7865 9613

T&J Electric (Cambodia) Co Ltd

Tel : +855 1076 2888 +855 766 88 66 88

PT Tera Joules Elektrindo (Indonesia)

Tel : +6221 2254 2222

General Enquiries: info@tjelec.com.sg

For further information, please contact your nearest dealer:

infnit
PRODUCT CATALOGUE

T&J



At the heart of every stunning design,
the functionality is just as good
as the aesthetics.



infini

Every part were worked out with great ingenuity in detail, and expertly crafted with high precision. Whether in safety and reliability, we always want to provide users with complete peace of mind.



White (WH)



Charcoal Black (ST)



Dark Champagne (PS7)



Champagne Grey (ST5)



SWITCHES



HC2711-B-WH

WHITE (WH)

infnit

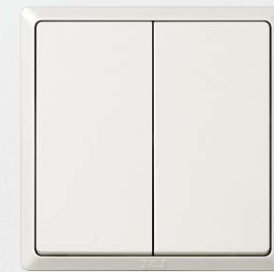

HC2712-WH

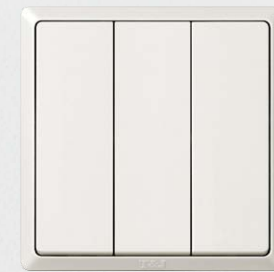

HC2713-WH

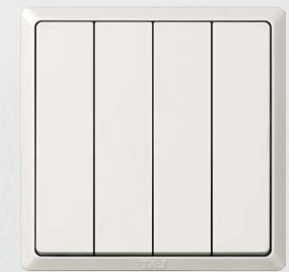

HC2714-WH



HC2711L-WH



HC2712L-WH



HC2713L-WH

infini



HC8613SUSB2-ST



HC8613S-ST



HC8318SUSB2-ST

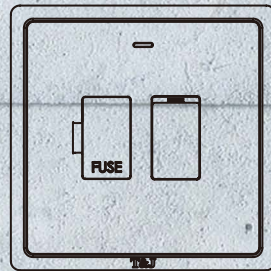

HC6813FSL-ST



HC8727-ST

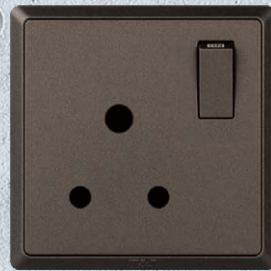

HC8615S-ST

SOCKET OUTLETS



HC8613SDUSB-DP-ST

CHARCOAL BLACK (ST)

DATA COMMUNICATIONS



HC4201HDMI-USB-PS7

DARK CHAMPAGNE (PS7)



infini



HC4226KT-ST5



HC4201DMB-ST5



HC2700IR-ST5



HC4201AL-ST5



HC8688-ST5



HC8668-ST5

HOTEL APPLICATIONS



HC8318USB2-ST5

CHAMPAGNE GREY (ST5)

MULTI GANG SOLUTIONS



2 Gang

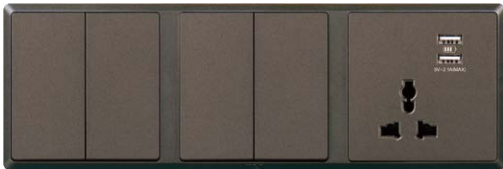

3 Gang



4 Gang









5 Gang



1 Switches

* Available In WH, ST, PS7 And ST5.

	Product	Model No.	Description	Pack(carton/box/number)
1		HC2711 HC2711-2 HC2761 HC2761-2 HC2715	16A 1 Gang 1 Way Switch 16A 1 Gang 2 Way Switch 10A 1 Gang 1 Way Retractive Switch 10A 1 Gang 2 Way Retractive Switch 10A 1 Gang Intermediate Switch	100/10/1 100/10/1 100/10/1 100/10/1 100/10/1
2		HC2711L HC2711L-2 HC2761L HC2761L-2 HC2721L-2DP HC2721L-DP	16A 1 Gang 1 Way Switch with LED indicator 16A 1 Gang 2 Way Switch with LED indicator 10A 1 Gang 1 Way Retractive Switch with LED indicator 10A 1 Gang 2 Way Retractive Switch with LED indicator 20A 1 Gang 2 Way DP Switch with LED indicator 20A 1 Gang DP Switch with LED indicator	100/10/1 100/10/1 100/10/1 100/10/1 100/10/1 100/10/1
3		HC2712 HC2712-2 HC2762 HC2762-2 HC2725	16A 2 Gang 1 Way Switch 16A 2 Gang 2 Way Switch 10A 2 Gang 1 Way Retractive Switch 10A 2 Gang 2 Way Retractive Switch 10A 2 Gang Intermediate Switch	100/10/1 100/10/1 100/10/1 100/10/1 100/10/1
4		HC2712L HC2712L-2 HC2762L HC2762L-2 HC2722L-DP	16A 2 Gang 1 Way Switch with LED indicator 16A 2 Gang 2 Way Switch with LED indicator 10A 2 Gang 1 Way Retractive Switch with LED indicator 10A 2 Gang 2 Way Retractive Switch with LED indicator 20A 2 Gang DP Switch with LED indicator	100/10/1 100/10/1 100/10/1 100/10/1 100/10/1
5		HC2713 HC2713-2 HC2763 HC2763-2	16A 3 Gang 1 Way Switch 16A 3 Gang 2 Way Switch 10A 3 Gang 1 Way Retractive Switch 10A 3 Gang 2 Way Retractive Switch	100/10/1 100/10/1 100/10/1 100/10/1
6		HC2713L HC2713L-2 HC2763L HC2763L-2	16A 3 Gang 1 Way Switch with LED indicator 16A 3 Gang 2 Way Switch with LED indicator 10A 3 Gang 1 Way Retractive Switch with LED indicator 10A 3 Gang 2 Way Retractive Switch with LED indicator	100/10/1 100/10/1 100/10/1 100/10/1
7		HC2714 HC2714-2 HC2764 HC2764-2	16A 4 Gang 1 Way Switch 16A 4 Gang 2 Way Switch 10A 4 Gang 1 Way Retractive Switch 10A 4 Gang 2 Way Retractive Switch	100/10/1 100/10/1 100/10/1 100/10/1
8		HC2714L HC2714L-2 HC2764L HC2764L-2	16A 4 Gang 1 Way Switch with LED indicator 16A 4 Gang 2 Way Switch with LED indicator 10A 4 Gang 1 Way Retractive Switch with LED indicator 10A 4 Gang 2 Way Retractive Switch with LED indicator	100/10/1 100/10/1 100/10/1 100/10/1
9		HC2711-B	10A 1 Gang Bell Switch	100/10/1
10		HC6813FSL	13A Switched Fused Connection Unit with LED indicator	100/10/1

1 Switches

	Product	Model No.	Description	Pack(carton/box/number)
11		HC2732L HC2750L	32A 1 Gang DP Switch with LED indicator 50A 1 Gang DP Switch with LED indicator	100/10/1 100/10/1
12		HC2771 HC2781	6A 1 Gang Blind Switch (Up Off Down) 6A 1 Gang Retractive Blind Switch	50/5/1 50/5/1
13		HC2772 HC2782	6A 2 Gang Blind Switch (Up Off Down) 6A 2 Gang Retractive Blind Switch	50/5/1 50/5/1

2 Sockets

	Product	Model No.	Description	Pack(carton/box/number)
1		HC8613S	13A 1 Gang Switched Socket	100/10/1
2		HC8613SD	13A 2 Gang Switched Socket	50/5/1
3		HC8613SDUSB-DP	13A 2 Gang Square Pin Socket with DP Switch with 3.6A USB Power Port	50/5/1
4		HC8613SUSB2	13A 1 Gang Square Pin Socket with Switch with 2 Gang 2.1A USB Power	100/10/1
5		HC8615S	15A 1 Gang Switched Socket	100/10/1
6		HC8318	13A 1 Gang 2 Pin + Earth Universal Socket	100/10/1
7		HC8318S	13A 1 Gang 2 Pin + Earth Switched Universal Socket	100/10/1
8		HC8318SD	13A 2 Gang 2 Pin + Earth Switched Universal Socket	50/5/1

2 Sockets

	Product	Model No.	Description	Pack(carton/box/number)
9		HC8318SDUSB-DP	13A 2 Gang 3 Pole Universal Socket with Double Pole Switch with 3.6A USB Power	50/5/1
10		HC8318USB2	13A 1 Gang 3 Pole Universal Socket with Switch with 2 Gang 2.1A USB Power	100/10/1
11		HC8318USB2	13A 1 Gang 3 Pole Universal Socket with 2 Gang 2.1A USB Power	100/10/1
12		HC8727	16A 1 Gang 2 Pin + Earth German Socket	50/5/1







3 Data Communication

	Product	Model No.	Description	Pack(carton/box/number)
1		HC4201-PC HC4211-PC	1 Gang RJ45 Cat.5e Data Socket 1 Gang RJ45 Cat.6 Data Socket	100/10/1 100/10/1
2		HC4202-PC HC4212-PC	2 Gang RJ45 Cat.5e Data Socket 2 Gang RJ45 Cat.6 Data Socket	100/10/1 100/10/1
3		HC4201-TU	1 Gang RJ12 Telephone Socket (6 Pin)	100/10/1
4		HC4201TV	1 Gang TV Socket with surge protection	100/10/1
5		HC4211PC-TU	1 Gang RJ45 Cat.6 Data Socket + RJ12 Telephone Socket (6 Pin)	100/10/1
6		HC4201TV-PC	1 Gang TV Socket with surge protection + RJ45 Cat.5e Data Socket	100/10/1
7		HC4201HDMI-USB	HDMI with USB Socket	100/10/1



3 Data Communication

	Product	Model No.	Description	Pack(carton/box/number)
8		HC4201VGA-EO	VGA Port + φ3.5 Stereophone Socket	100/10/1
9		HC4201ETV	1 Gang Sat. TV Socket	100/10/1





4 Electronic

	Product	Model No.	Description	Pack(carton/box/number)
1		HC4201M2 HC4201KM2	630W 230V 1 Gang Dimmer (rotate on / off) 1000W 230V 1 Gang Dimmer (rotate on / off)	50/5/1 50/5/1
2		HC4211M2	1~10V 1 Gang DC Output Dimmer Only for Dimmable Electronic Ballast (push on / off)	50/5/1
3		HC4201MMD	100VA 1 Gang Fan Control (rotate on / off)	50/5/1
4		HC4301V	6W 1 Gang Volume Switch with emergency alarm	50/5/1
5		HC4201LIR	500W 230V 1 Gang IR Motion Sensor Detector (With Fire Control Outlet)(Neutral Live Line Input)	50/5/1
5		HC4201LSC	500W 230V 1 Gang Voice Activated Switch With time delay (With fire control outlet)(Neutral Live Line Input)	100/10/1

5 Hotel

	Product	Model No.	Description	Pack(carton/box/number)
1		HC4201DMB	3A Bell Switch with "Do Not Disturb" + "Make Up Room" indicator	100/10/1
2		HC2700IR	IR Motion Floor Lamp	100/10/1

5 Hotel

	Product	Model No.	Description	Pack(carton/box/number)
3		HC4226KT	20A 100-240VAC 1 Gang Key Card Switch with time delay, voltage drop	50/5/1
		HC4206KT9	10A 9-24V 1 Gang Key-card Switch with time delay, low voltage passive	
		HC4208KT9	10A 9-24V 1 Gang Low Frequency Key-card Switch with time delay, low voltage passive	
		HC4209KT9	10A 9-24V 1 Gang High Frequency Key-card Switch with time delay, low voltage passive	
		HC4206KT	10A 100-240VAC 1 Gang Key-card Switch with time delay, high voltage passive, switching voltage drop	
		HC4208KT	10A 100-240VAC 1 Gang Low Frequency Key-card Switch with time delay, high voltage passive, switching voltage drop	
		HC4228KT	20A 100- 240VAC 1 Gang Low Frequency Key-card Switch with time delay, switching voltage drop	
		HC4209KT	10A 100-240VAC 1 Gang High Frequency Key-card Switch with time delay, high voltage passive, switching voltage drop	
HC4229KT	20A 100- 240VAC 1 Gang High Frequency Key-card Switch with time delay, switching voltage drop			
4		HC4201AL	SOS Switch	100/10/1
5		DL-HC-TA102	220VAC High voltage thermostat, two single-pole double-throw relays, without RS485 comm. port	50/10/1
		DL-HC-TA102M	220VAC High voltage thermostat, two single-pole double-throw relays, with RS485 comm. port (from system)	
		DL-HC-TA191M	12VDC Low voltage thermostat, RS485 comm. port (from system), for low-voltage system application	
6		HC8668	115/230V Shaver Socket with overcurrent protection	20/1/1
7		HC8688	115/230V Shaver Socket with overcurrent protection	25/1/1



6 Accessories

	Product	Model No.	Description	Pack(carton/box/number)
1		HC1001	1 Gang Blank Plate	200/20/1
2		HC1001D	2 Gang Blank Plate	100/10/1
3		HC1102	2 Gang Frame (86 type)	100/1/1

6 Accessories

	Product	Model No.	Description	Pack(carton/box/number)
4		HC1103	3 Gang Frame (86 type)	50/1/1
5		HC1104	4 Gang Frame (86 type)	50/1/1
6		HC1105	5 Gang Frame (86 type)	50/1/1

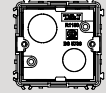
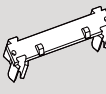
7 MountingBox

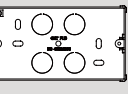
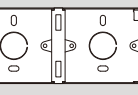
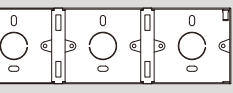
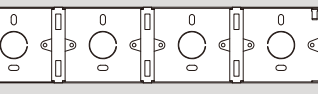
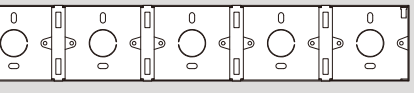
	Product	Model No.	Description	Pack(carton/box/number)
1		R1150	1 Gang Mounting Box 48.4mm Depth	200/1/1
2		R141	Spacer (For R1150/s567)	3000/150/1
3		M1247	1 Gang 47mm Bs Metallic Patten Box (Flush Mounting)	100/1/1
4		M1047D	2 Gang 47mm Metallic Patten Box (Flush Mounting)	50/5/1
5		M1472	2 Gang 47mm Folded Mounting Box	50/1/1
6		M1473	3 Gang 47mm Folded Mounting Box	20/1/1
7		M1474	4 Gang 47mm Folded Mounting Box	25/1/1
8		M1475	5 Gang 47mm Folded Mounting Box	25/1/1

Dimension

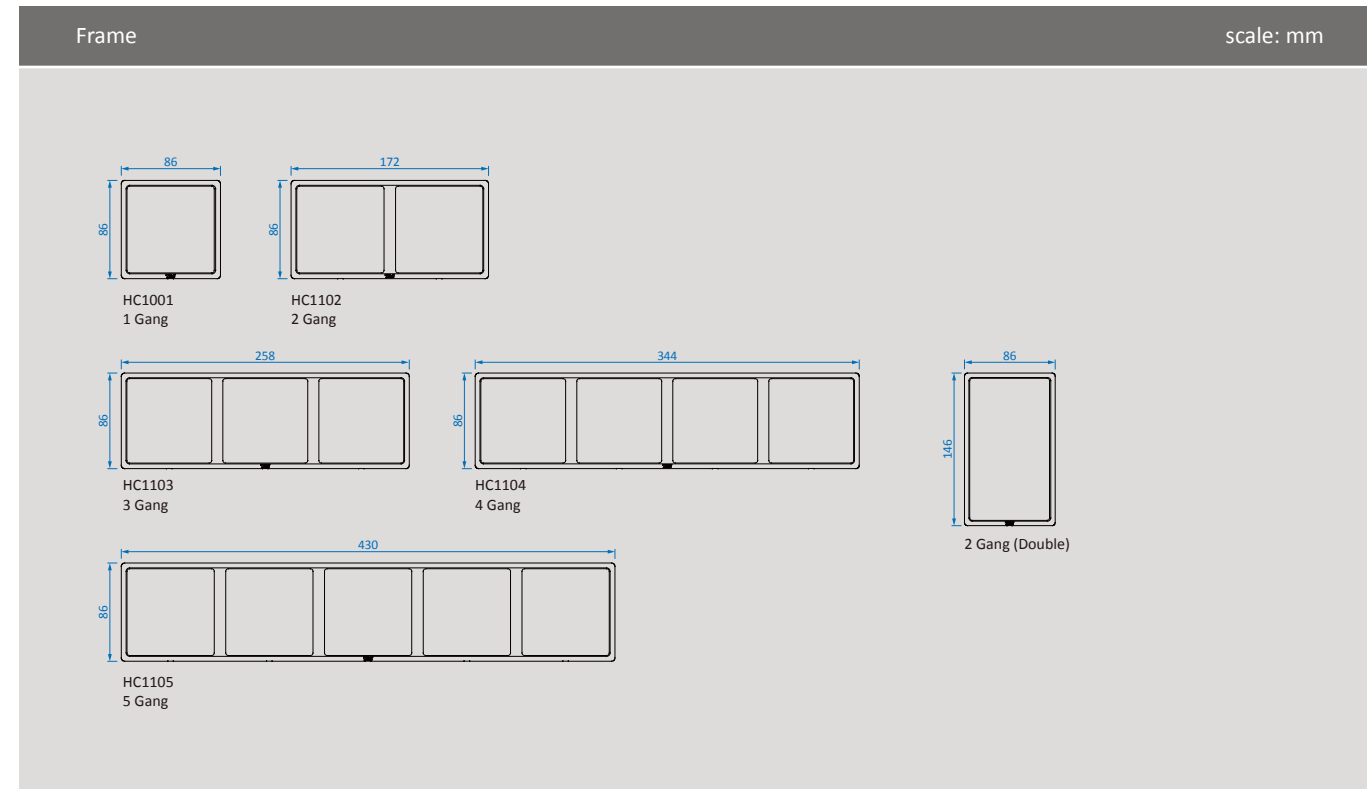

Installations

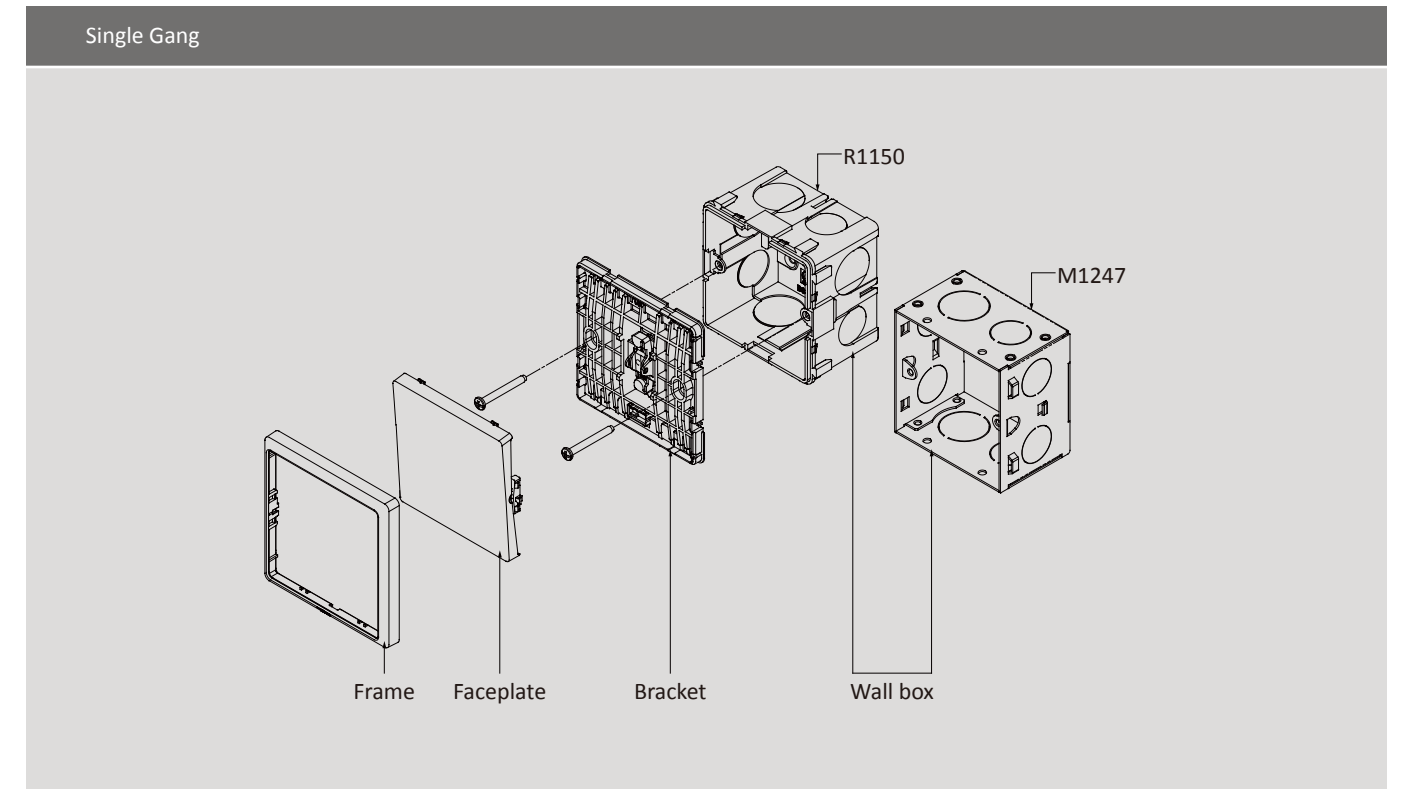

Wall Box

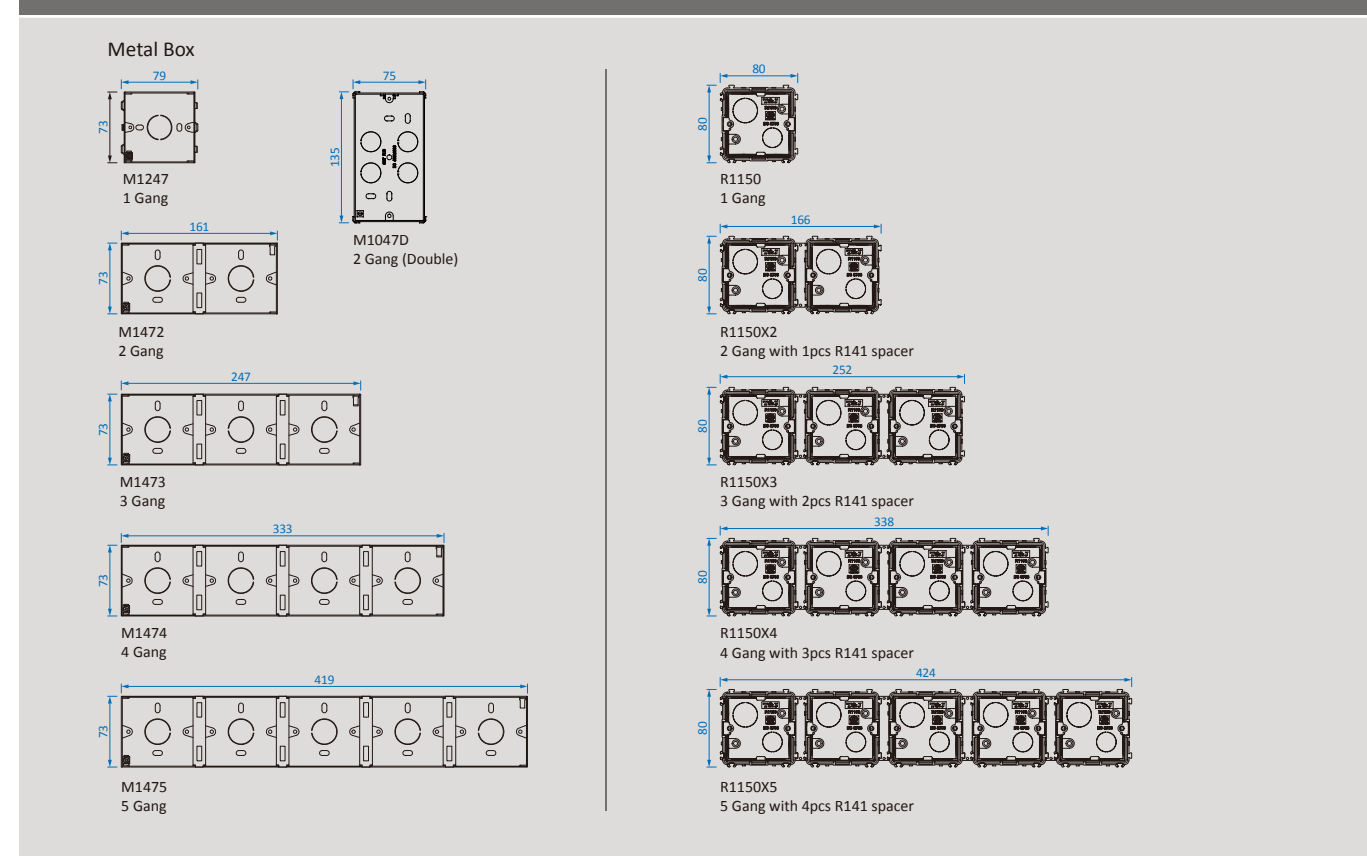

Multi Gang

