

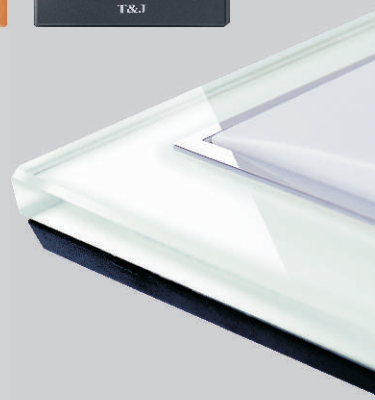

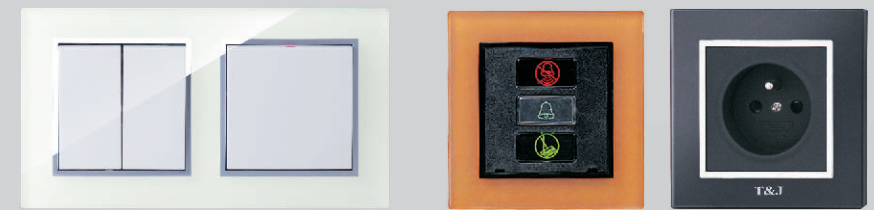

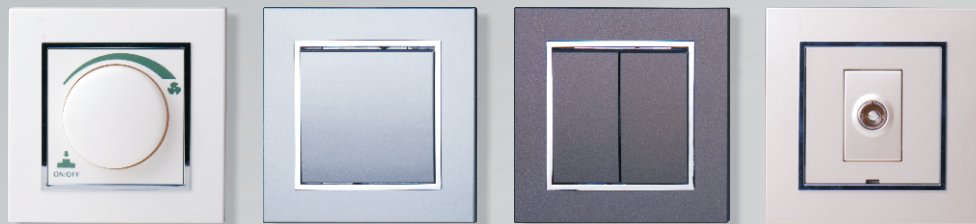

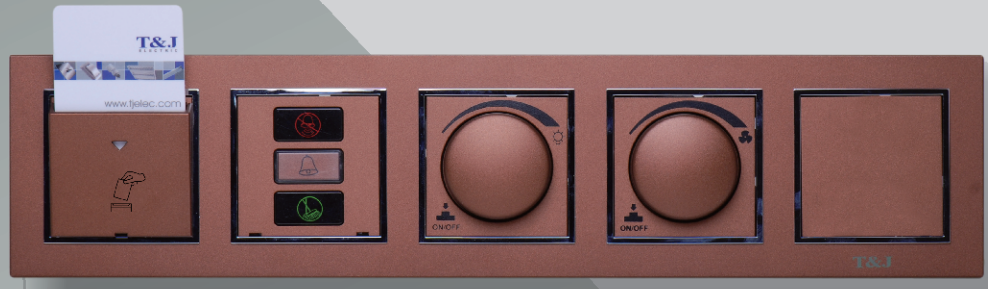









Lavina



Lavina glass or polycarbonate plates can be mounted in either British standard square or European round wall boxes. Lavina offers an exceptionally wide variety of painted colours with electroplated metallic accents that are well-suited for almost any decor. Solid glass plates are available in Ice Blue, Piano Black and Pure White (matt or gloss).





Switches			
Product	Model No.	Description	Remarks
	JC271 JC271-2 JC271-DP JC2720-DP JC277	10A 1 Gang 1 Way Switch 10A 1 Gang 2 Way Switch 10A 1 Gang DP Switch 20A 1 Gang DP Switch 10A 1 Gang Intermediate Switch	Nominal plate size: 86x86mm Minimum wall box depth: 40mm Pack: (carton / box): 60/10
	JC271L JC271L-2 JC271L-DP JC2720L-DP	10A 1 Gang 1 Way Switch with LED indicator 10A 1 Gang 2 Way Switch with LED indicator 10A 1 Gang DP Switch with LED indicator 20A 1 Gang DP Switch with LED indicator	Nominal plate size: 86x86mm Minimum wall box depth: 40mm Pack: (carton / box): 60/10
	JC272 JC272-2	10A 2 Gang 1 Way Switch 10A 2 Gang 2 Way Switch	Nominal plate size: 86x86mm Minimum wall box depth: 40mm Pack: (carton / box): 60/10
	JC272L JC272L-2	10A 2 Gang 1 Way Switch with LED indicator 10A 2 Gang 2 Way Switch with LED indicator	Nominal plate size: 86x86mm Minimum wall box depth: 40mm Pack: (carton / box): 60/10
	JC273 JC273-2	10A 3 Gang 1 Way Switch 10A 3 Gang 2 Way Switch	Nominal plate size: 86x86mm Minimum wall box depth: 40mm Pack: (carton / box): 50/5
	JC232	32A 1 Gang DP Switch	Nominal plate size: 86x86mm Minimum wall box depth: 40mm Pack: (carton / box): 50/5
	JC232L	32A 1 Gang DP Switch with neon	Nominal plate size: 86x86mm Minimum wall box depth: 40mm Pack: (carton / box): 50/5
	JC245	45A 1 Gang DP Switch	Nominal plate size: 86x86mm Minimum wall box depth: 40mm Pack: (carton / box): 50/5
	JC245L	45A 1 Gang DP Switch with neon	Nominal plate size: 86x86mm Minimum wall box depth: 40mm Pack: (carton / box): 50/5
	JC261 JC261-2	10A 1 Gang 1 Way Retractive Switch 10A 1 Gang 2 Way Retractive Switch	Nominal plate size: 86x86mm Minimum wall box depth: 40mm Pack: (carton / box): 60/10





Retractive Switches			
Product	Model No.	Description	Remarks
	JC261L JC261L-2	10A 1 Gang 1 Way Retractive Switch with LED indicator 10A 1 Gang 2 Way Retractive Switch with LED indicator	Nominal plate size: 86x86mm Minimum wall box depth: 40mm Pack: (carton / box): 60/10
	JC262 JC262-2	10A 2 Gang 1 Way Retractive Switch 10A 2 Gang 2 Way Retractive Switch	Nominal plate size: 86x86mm Minimum wall box depth: 40mm Pack: (carton / box): 60/10
	JC262L JC262L-2	10A 2 Gang 1 Way Retractive Switch with LED indicator 10A 2 Gang 2 Way Retractive Switch with LED indicator	Nominal plate size: 86x86mm Minimum wall box depth: 40mm Pack: (carton / box): 60/10
	JC263 JC263-2	10A 3 Gang 1 Way Retractive Switch 10A 3 Gang 2 Way Retractive Switch	Nominal plate size: 86x86mm Minimum wall box depth: 40mm Pack: (carton / box): 50/5
	JC271-B	10A 1 Gang 1 Way Bell Switch	Nominal plate size: 86x86mm Minimum wall box depth: 40mm Pack: (carton / box): 60/10
	JC223	10A Blind Switch	Nominal plate size: 86x86mm Minimum wall box depth: 40mm Pack: (carton / box): 60/10

Dimmers			
Product	Model No.	Description	Remarks
	JC2-M2	600W 230V 1 Gang Dimmer (push on / off)	Nominal plate size: 86x86mm Minimum wall box depth: 40mm Pack(carton/box):50/5
	JC2-1KM2	1000W 230V 1 Gang Dimmer (rotate on / off)	Nominal plate size: 86x86mm Minimum wall box depth: 40mm Pack(carton/box):50/5
	JC2-DCM2	1~10V 1 Gang DC Output Dimmer Only for Dimmable Electronic Ballast (push on / off)	Nominal plate size: 86x86mm Minimum wall box depth: 40mm Pack(carton/box):50/5

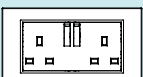

Fan Controls

Product	Model No.	Description	Remarks
	JC2-M3	500VA 230V 1 Gang Fan Control (push on / off)	Nominal plate size: 86x86mm Minimum wall box depth: 40mm Pack(carton/box):50/5

BS Sockets

Product	Model No.	Description	Remarks
	JC813	13A 1 Gang Unswitched Socket	Nominal plate size: 86x86mm Minimum wall box depth: 40mm Pack: (carton / box): 60/10
	JC813SA JC813SA-SP	13A 1 Gang Switched Socket 13A 1 Gang DP Switched Socket	Nominal plate size: 86x86mm Minimum wall box depth: 40mm Pack: (carton / box): 60/10
	JC813SL	13A 1 Gang Switched Socket with LED indicator	Nominal plate size: 86x86mm Minimum wall box depth: 40mm Pack: (carton / box): 60/10
	JC813SD JC813SD-DP	13A 2 Gang Switched Socket 13A 2 Gang DP Switched Socket	Nominal plate size:155x86mm Minimum wall box depth:40mm Pack(carton/box):20/1
	JC818	13A 1 Gang 2 Pin + Earth Universal Socket	Nominal plate size: 86x86mm Minimum wall box depth: 40mm Pack: (carton / box): 60/10







Schuko Products

Product	Model No.	Description	Remarks
	JC816U	16A 1 Gang 2 Pin + Earth German Socket	Nominal plate size: 86x86mm Minimum wall box depth: 40mm Pack: (carton / box): 60/10
	JC816V	16A 1 Gang 2 Pin + Earth French Socket	Nominal plate size: 86x86mm Minimum wall box depth: 40mm Pack: (carton / box): 60/10



Schuko Products

Product	Model No.	Description	Remarks
	JC810U2	10A 2 Gang 2 Pin Socket	Nominal plate size: 86x86mm Minimum wall box depth: 40mm Pack: (carton / box): 60/10







Audio and Video Products

Product	Model No.	Description	Remarks
	JC8416U	10A/16A 1 Gang 2 Pin Socket	Nominal plate size: 86x86mm Minimum wall box depth: 40mm Pack(carton/box): 60/10
	JC8416U2	10/16A 2 Gang 2 Pin Euro American Socket	Nominal plate size: 86x86mm Minimum wall box depth: 40mm Pack(carton/box): 60/10
	JC801-SB	1 Gang Speaker Socket (banana jack)	Nominal plate size: 86x86mm Minimum wall box depth: 40mm Pack(carton/box): 60/10
	JC801AVO	1 Gang Video Socket + 1 Gang Stereo Audio RCA Socket	Nominal plate size: 86x86mm Minimum wall box depth: 40mm Pack(carton/box): 60/10
	JC801AO	1 Gang Stereo Audio RCA Socket	Nominal plate size: 86x86mm Minimum wall box depth: 40mm Pack(carton/box): 60/10
	JC801VO	1 Gang Video RCA Socket	Nominal plate size: 86x86mm Minimum wall box depth: 40mm Pack(carton/box): 60/10
	JC801SO	1 Gang S-video Socket	Nominal plate size: 86x86mm Minimum wall box depth: 40mm Pack(carton/box): 60/10
	JC801EO	1 Gang φ3.5 Earphone Socket (3.5mm jack)	Nominal plate size: 86x86mm Minimum wall box depth: 40mm Pack(carton/box): 60/10











Audio and Video Products

Product	Model No.	Description	Remarks
	JC801HDMI	1 Gang HDMI Socket	Nominal plate size: 86x86mm Minimum wall box depth: 40mm Pack(carton/box): 60/10
	JC801KO	1 Gang Audio Socket Module (XLR3 socket)	Nominal plate size: 86x86mm Minimum wall box depth: 40mm Pack(carton/box): 60/10







Telecommunication Products

Product	Model No.	Description	Remarks
	JC811USB	1 Gang 2A USB Power Charger	Nominal plate size: 86x86mm Minimum wall box depth: 40mm Pack(carton/box): 60/10
	JC812USB	2 Gang 2A USB Power Charger	Nominal plate size: 86x86mm Minimum wall box depth: 40mm Pack(carton/box): 50/5
	JC811USBA	1 Gang 2A USB Power Charger	Nominal plate size: 86x86mm Minimum wall box depth: 40mm Pack(carton/box): 50/5
	JC812USBA	2 Gang 2A USB Power Charger	Nominal plate size: 86x86mm Minimum wall box depth: 40mm Pack(carton/box): 50/5
	JC811-4TU JC811-6TU	1 Gang RJ11 Telephone Socket (4 Pin) 1 Gang RJ12 Telephone Socket (6 Pin)	Nominal plate size: 86x86mm Minimum wall box depth: 40mm Pack(carton/box): 60/10
	JC812-4TU JC812-6TU	2 Gang RJ11 Telephone Socket (4 Pin) 2 Gang RJ12 Telephone Socket (6 Pin)	Nominal plate size: 86x86mm Minimum wall box depth: 40mm Pack(carton/box): 60/10
	JC811PC-4TU JC811PC-6TU	1 Gang RJ45 Cat.5e Data Socket + RJ11 Telephone Socket (4 Pin) 1 Gang RJ45 Cat.5e Data Socket + RJ12 Telephone Socket (6 Pin)	Nominal plate size: 86x86mm Minimum wall box depth: 40mm Pack(carton/box): 60/10



Telecommunication Products

Product	Model No.	Description	Remarks
	JC821PC-4TU JC821PC-6TU	1 Gang RJ45 Cat.6 Data Socket + RJ11 Telephone Socket (4 Pin) 1 Gang RJ45 Cat.6 Data Socket + RJ12 Telephone Socket (6 Pin)	Nominal plate size: 86x86mm Minimum wall box depth: 40mm Pack(carton/box): 60/10
	JC811PC	1 Gang RJ45 Cat.5e Data Socket	Nominal plate size: 86x86mm Minimum wall box depth: 40mm Pack(carton/box): 60/10
	JC821PC	1 Gang RJ45 Cat.6 Data Socket	Nominal plate size: 86x86mm Minimum wall box depth: 40mm Pack(carton/box): 60/10
	JC812PC	2 Gang RJ45 Cat.5e Data Socket	Nominal plate size: 86x86mm Minimum wall box depth: 40mm Pack(carton/box): 60/10
	JC822PC	2 Gang RJ45 Cat.6 Data Socket	Nominal plate size: 86x86mm Minimum wall box depth: 40mm Pack(carton/box): 60/10
	JC801PC-TM	Cat.5e Data Socket and BT Socket (Master)	Nominal plate size: 86x86mm Minimum wall box depth: 40mm Pack(carton/box): 60/10
	JC801TM JC801TS	1 Gang BT Master Telephone Socket Module 1 Gang BT Secondary Telephone Socket Module	Nominal plate size: 86x86mm Minimum wall box depth: 40mm Pack(carton/box): 60/10
	JC801TV	1 Gang TV Socket with surge protection	Nominal plate size: 86x86mm Minimum wall box depth: 40mm Pack(carton/box): 60/10
	JC801TV-FM	1 Gang TV + FM Socket	Nominal plate size: 86x86mm Minimum wall box depth: 40mm Pack(carton/box): 60/10
	JC801TV-FM-SAT	1 Gang Triplex Socket (Sat+TV+FM)	Nominal plate size: 86x86mm Minimum wall box depth: 40mm Pack(carton/box): 60/10





Telecommunication Products

Product	Model No.	Description	Remarks
	JC801TV-PC	1 Gang TV Socket with surge protection + RJ45 Cat.5e Data Socket	Nominal plate size: 86x86mm Minimum wall box depth: 40mm Pack(carton/box): 60/10
	JC802TV	2 Gang TV Socket with surge protection	Nominal plate size: 86x86mm Minimum wall box depth: 40mm Pack(carton/box): 60/10
	JC801TV-4TU	1 Gang TV Socket with surge protection + RJ11 Telephone Socket (4 Pin)	Nominal plate size: 86x86mm Minimum wall box depth: 40mm Pack(carton/box): 60/10
	JC801TV-6TU	1 Gang TV Socket with surge protection + RJ12 Telephone Socket (6 Pin)	Nominal plate size: 86x86mm Minimum wall box depth: 40mm Pack(carton/box): 60/10
	JC801ETV	1 Gang Sat. TV Socket	Nominal plate size: 86x86mm Minimum wall box depth: 40mm Pack(carton/box): 50/5
	JC802ETV	2 Gang Sat. TV Socket	Nominal plate size: 86x86mm Minimum wall box depth: 40mm Pack(carton/box): 60/10

Hotel Products

Product	Model No.	Description	Remarks
	JC2C-DM	"Do Not Disturb" + "Make Up Room" Indicator	Nominal plate size: 86x86mm Minimum wall box depth: 40mm Pack(carton/box):60/10
	JC2C-DMB	4A Bell Switch with "Do Not Disturb" + "Make Up Room" indicator	Nominal plate size: 86x86mm Minimum wall box depth: 40mm Pack(carton/box):60/10
	JC6-2KT	20A 100-240V Keycard switch with time delay	Nominal plate size: 86x86mm Minimum wall box depth: 40mm Pack(carton/box):50/5
	JC8-2KT	20A 100-240V Low frequency RFID keycard switch with time delay	
	JC9-2KT	20A 100-240V High frequency RFID Keycard switch with time delay	
	JC6-KT9	10A 9-24V Keycard switch with time delay, Low voltage, Dry-contact output	
	JC8-KT9	10A 9-24V Low frequency RFID Keycard switch with time delay, Low voltage, Dry-contact output	
	JC9-KT9	10A 9-24V High frequency RFID Keycard switch with time delay, Low voltage, Dry-contact output	

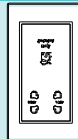

Hotel Products



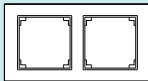

Product	Model No.	Description	Remarks
	JC2-AL	3A 1 Gang Alarm	Nominal plate size: 86x86mm Minimum wall box depth: 40mm Pack(carton/box):60/10
	JC2700	1W 220V Night Light	Nominal plate size: 86x86mm Minimum wall box depth: 40mm Pack(carton/box):60/10
	JC828	115/230V Shaver Socket with overcurrent protection (max:20VA)	Nominal plate size: 155x86mm Minimum wall box depth: 40mm Pack(carton/box):25/1
	JC2-LIR	1000W 230V IR Motion Detector with fire control outlet	Nominal plate size: 86x86mm Minimum wall box depth: 40mm Pack(carton/box):50/5

Accessories



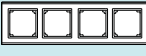

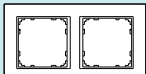

Product	Model No.	Description	Remarks
	JC1101	1 Gang Frame	Nominal plate size: 86x86mm Pack(carton/box): 200/20

Accessories

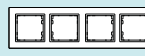
Product	Model No.	Description	Remarks
	JC1111	1 Gang Frame (for key card switch)	Nominal plate size:86x86mm Pack(carton/box): 200/20
	JC1102	2 Gang Frame	Nominal plate size:157x86mm Pack(carton/box): 400/20
	JC1103	3 Gang Frame	Nominal plate size:228x86mm Pack(carton/box): 100/5

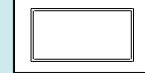
Accessories			
Product	Model No.	Description	Remarks
	JC1113	3 Gang Frame (for key card switch)	Nominal plate size: 228x86mm Pack(carton/box): 100/5
	JC1104	4 Gang Frame	Nominal plate size:299x86mm Pack(carton/box): 100/10
	JC1105	5 Gang Frame	Nominal plate size:370x86mm Pack(carton/box): 150/1
	JC1101D	Shaver Socket Frame	Nominal plate size:155x86mm Pack(carton/box): 400/20
	JB1101	1 Gang Glass Frame	Nominal plate size:86x86mm Pack(carton/box): 100/20
	JB1111	1 Gang Glass Frame (for key card switch)	Nominal plate size:86x86mm Pack(carton/box): 100/20
	JB1102	2 Gang Glass Frame	Nominal plate size:157x86mm Pack(carton/box): 50/5

Accessories			
Product	Model No.	Description	Remarks
	JB1103	3 Gang Glass Frame	Nominal plate size:228x86mm Pack(carton/box): 50/5

Accessories			
Product	Model No.	Description	Remarks
	JB1113	3 Gang Glass Frame (for key card switch)	Nominal plate size:228x86mm Pack(carton/box): 50/5
	JB1104	4 Gang Glass Frame	Nominal plate size:299x86mm Pack(carton/box): 50/5
	JB1105	5 Gang Glass Frame	Nominal plate size:370x86mm Pack(carton/box):50/5
	JB1101D	Glass Shaver Socket Frame	Nominal plate size:155x86mm Pack(carton/box):50/5
	JC1511	1 Gang Deco Modular Frame	Nominal plate size: 86x86mm Pack(carton/box): 200/10
	JC1512	2 Gang Deco Modular Frame	Nominal plate size: 86x86mm Pack(carton/box): 200/10
	JC525	1 Gang Flex Outlet	Nominal plate size: 86x86mm Pack(carton/box): 50/5

* ask your salesman about the many different modular options

Dimensions Unit:mm

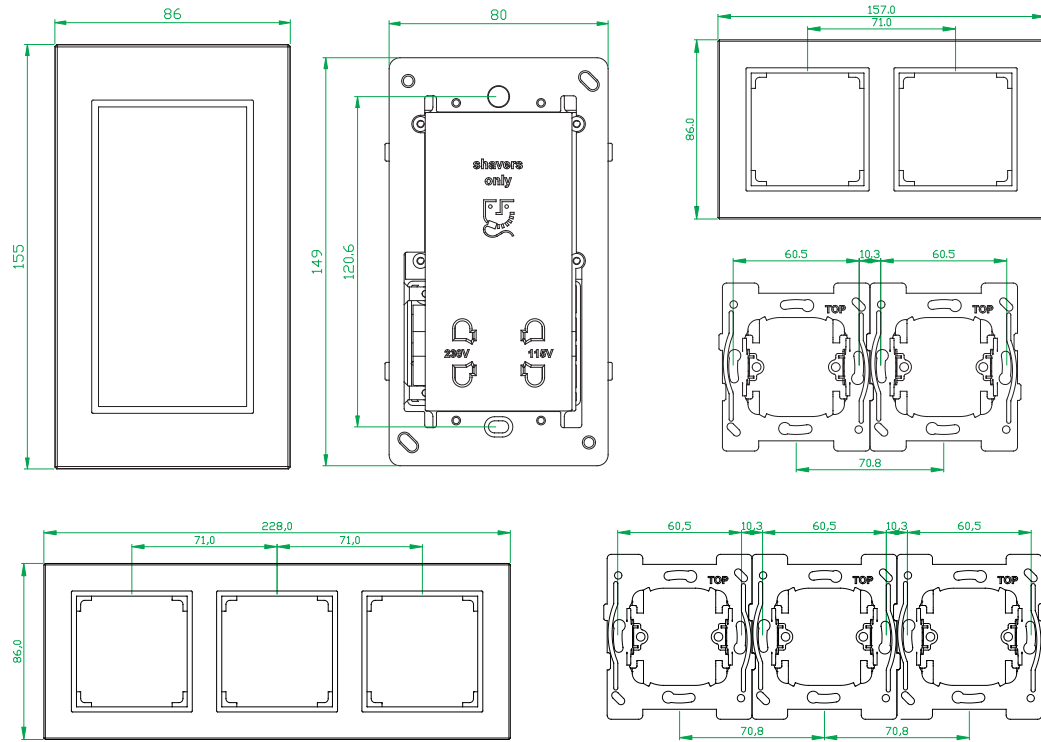

Dimensions Unit:mm

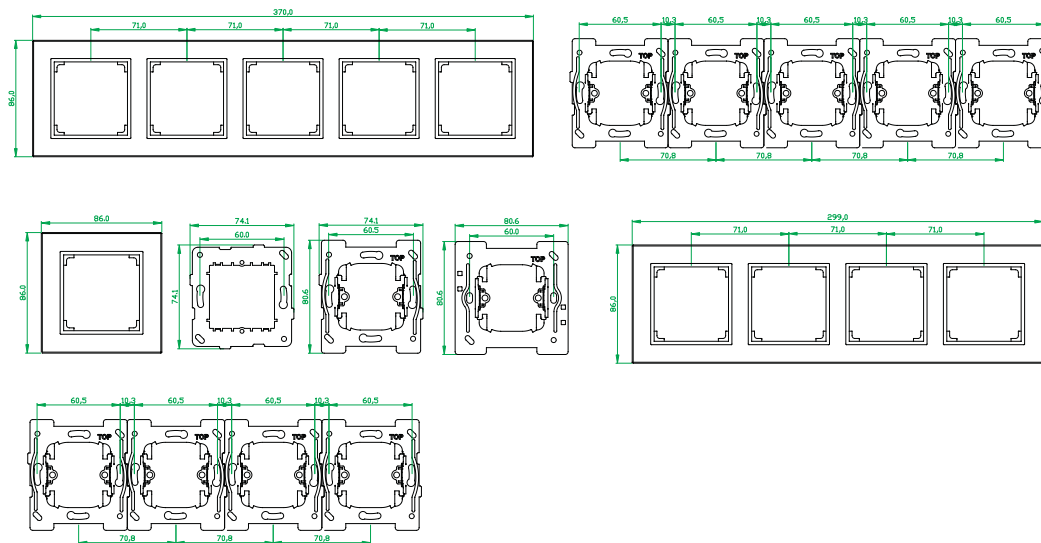

Product Code Rules

Lavina

JC 27 1 L - 2 - CPS

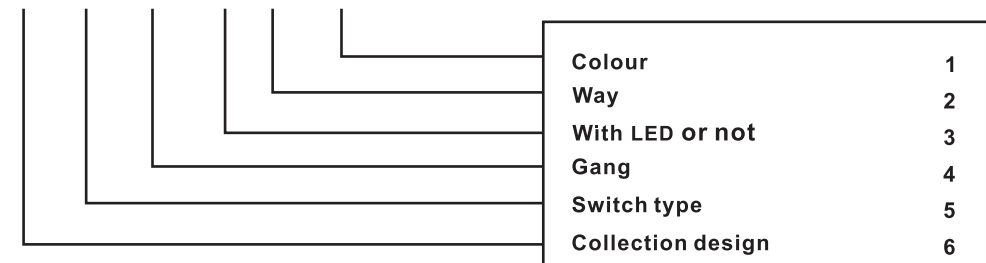

Available Options

	1	2	3	4	5	6
CH	White	2	L	1	27	CM B
CIW	Ivory White	2 Way	With Neon	1 Gang	Wide Switch	Colossal Alpine/Exclusif
CPS	Pearl Silver	Blank	Blank	2	21	G E
CCS	Cola Silver	1 Way	Without Neon	2 Gang	Round Switch	Ultimate Unique
CST	Matt Black			3	252	GC M
CCGO	Coffee Gold			3 Gang	Dimmer Switch	Titanium Metalclad
CCR	Cola Red			4	827	K P
01	Glass White			4 Gang	Schuko Socket	Radiance Armor
02	Glass Blue			5	810	R JC
03	Glass Black			5 Gang	GB Socket	Classy Lavina

Lavina

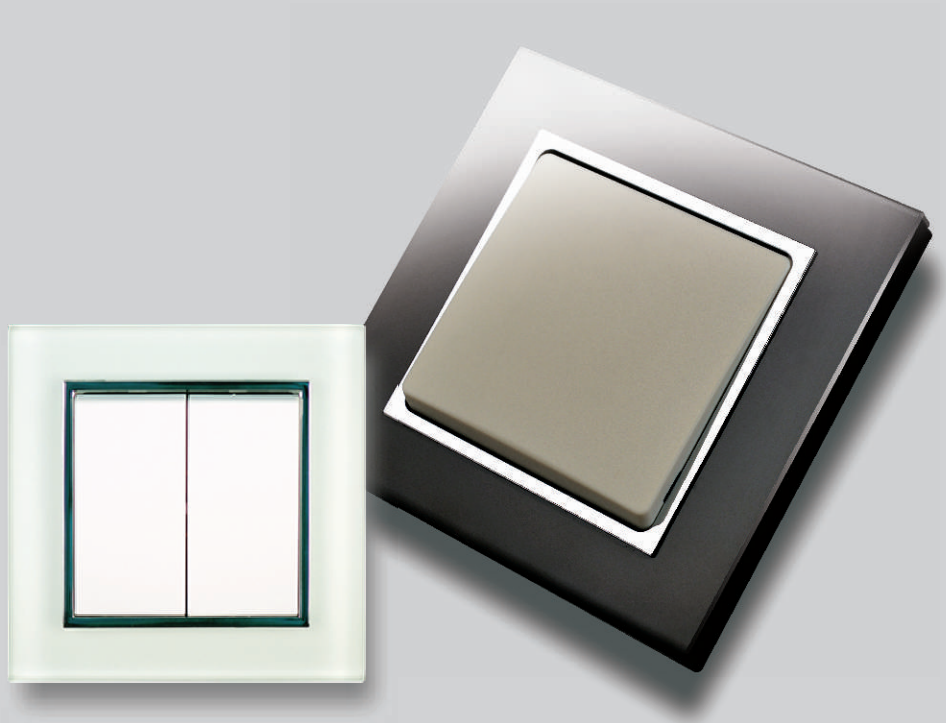

T&J

www.tjelec.com